

NEW

# Digital Microscope

HRX-01 | RX-100

**HIROX**  
<https://www.hirox.com>



Hirox Co.,Ltd. <https://www.hirox.com>  
2-15-17 Koenji Minami,Suginami-ku,Tokyo166-0003,Japan  
Tel:(+81) 3-3311-9911 Fax:(+81) 3-3311-7722 E-mail:tokyo2@hirox.com

Hirox-USA Inc. <https://www.hirox-usa.com>  
100 Commerce Way, Hackensack, NJ 07601  
Tel:(201)342-2600 Fax:(201) 342-7322  
Toll-Free:(866)HIROX-US E-mail:info@hirox-usa.com

Hirox China Co.,Ltd. <http://www.hirox.com.cn>  
Room 809, 8th Floor, Fortune International Plaza,  
No.43 Guo-Quan Road, Shanghai 200433, China.  
Tel:+86-21-6564-7772 Fax:+86-21-3362-5017 Email:info@hirox.com.cn

Hirox Korea Co.,Ltd. <http://www.hiroxkorea.com>  
B-501 Acrotower Bldg, 1591 Gwanyang-dong, Dongan-ku, Anyang-city,  
Gyeonggi-do, 431-908, Korea  
Tel:+82-31-385-1130 Fax:+82-31-385-9730 E-mail:yoon@hiroxkorea.com

Hirox Asia Ltd. <http://www.hirox-asia.com>  
Unit 827, 8/F, Ocean Centre, Harbour City, 5 Canton Road,  
Tsimshatsui Kowloon, Hong Kong  
Tel:+852 8198-9679 Fax: +852 3015-7657 E-mail:info@hirox-asia.com

Hirox Europe Ltd. <https://www.hirox-europe.com>  
Jyfel, 300 RN 6 Le Bois des Côtes, Bâtiment A F-69760 Limonest, France  
Tel:+33 426 25 03 40 Fax:+33 426 23 68 13 E-mail:info@hirox-europe.com

Contact

 **Global Source**  
EQUIP TO INNOVATE

The products in this catalog may be changed at any time, without notice.

PHP-2009-C061-A\_  
APP-P2009-0109

Fully Motorized | Ultra High Resolution | 3D Digital Microscope

# Motorized Lens & Motorized Stand for a completely new experience

We developed a fully motorized, fully automatic 3D digital microscope system by combining high precision motorized XYZ-axis stand with high resolution motorized zoom lenses.

*You can now fully control up to 7 motors: X, Y, Z, Light, Zoom, Objective and Rotation directly from the software!*

*The motorization allows a very high level of repeatability, by applying the exact same settings including camera settings, zoom and light, simply by clicking on an existing image.*

*Remotely controlling your microscope for industry 4.0 and beyond just got easier: the system can now be fully remote controlled via desktop sharing, to a new level never seen before.*



- One click changing magnification with Motorized Zoom Lens
- Precision control with Motorized Stand
- Fully Automatic System Enable Remote Observation



# Absolute High Resolution Image

HR-1020E

Telecentric Ultra High Resolution Motorized Zoom Lens (10-200x)

Astounding resolution, Accuracy, Usability.  
Aggregating the potential of telecentric lenses to the maximum

Introducing the new Hirox masterpiece: the new motorized telecentric zoom lens HR-1020E is the result of over 40 years of optical manufacturing and engineering excellence. Combined with the HRX-01, intelligent sensors compute in real time the lens zoom information, detect illumination adapters, register XY and Z position and record those conditions to redefine completely the user experience.

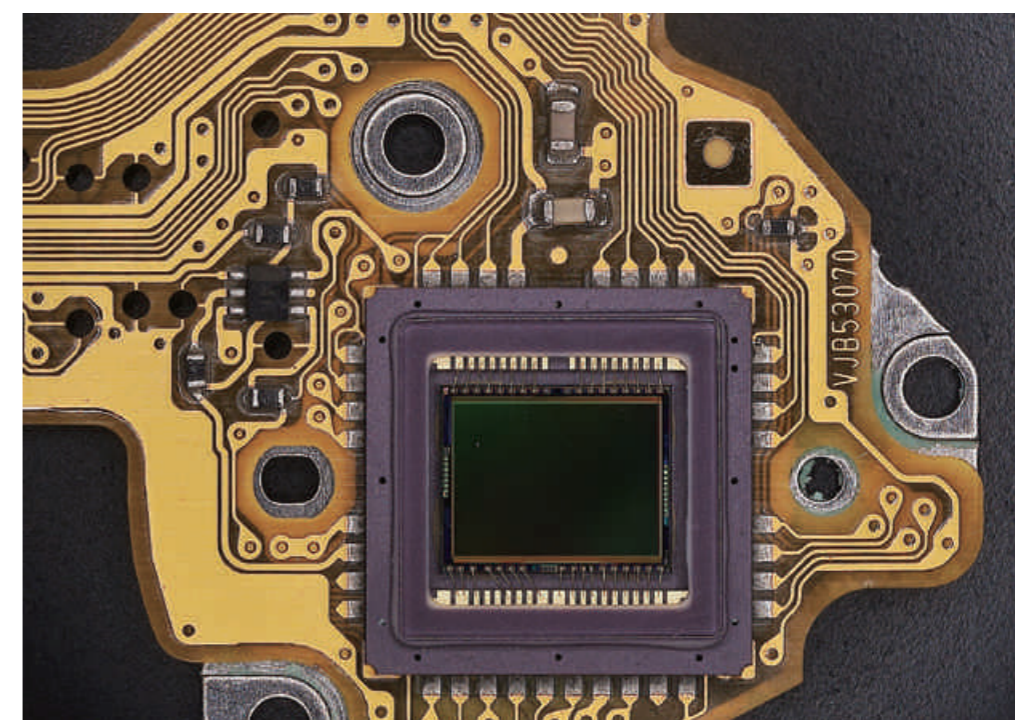

Mounted board(10x)

- Large aperture lens provides super high resolution and crystal clear image
- Fully motorized zoom lens for easy operation and improved accuracy
- Telecentric lens without distortion for precise measurement
- Wide angle high resolution one-shot observation with magnification starting from 10x



# Hirox Digital Microscope

The universal system for all your applications

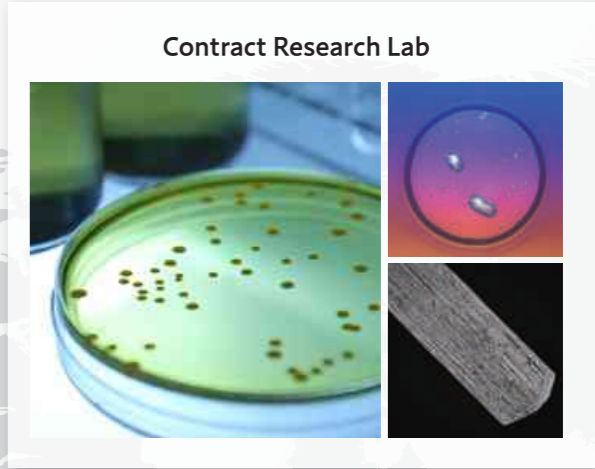
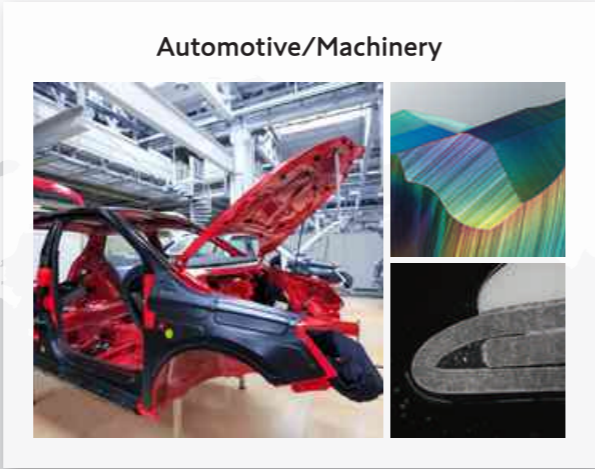
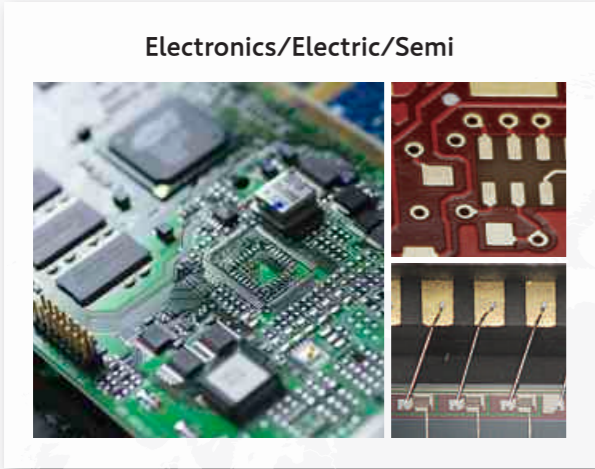

Digital Microscope made by Hirox, optical manufacturer and inventor of video microscopy since 1978.

From the time of our founding until now, we have three fundamental concepts that we continue to protect:

- 1: comfortable, stress-free observation environment. We aim to develop human-friendly equipment that is easy to handle so that it will become part of the body of the viewer.
- 2: absolute reality. With the lens technology cultivated over many years as the core, we pursue true images to the fullest.
- 3: sincerity to meet user expectations and produce results. Being able to produce high quality custom made products are one of the strengths of Hirox, our technical expertise enables us to adapt to the most demanding requests.

Manufacturing that does not allow compromise. It is a mission as a pioneer in the video microscopy industry.

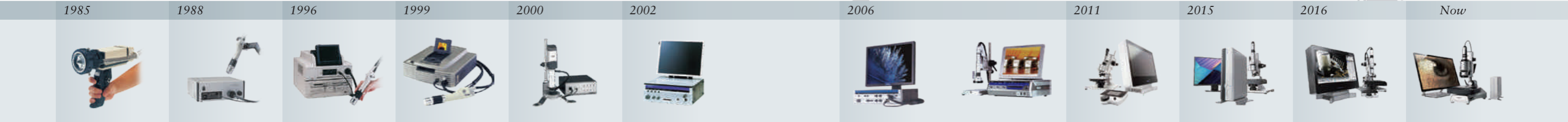



### Automatic Adapter Recognition

With the new lens series, the adapter attached to the lens is automatically recognized. The operators never forget to register the adapter information to the application.

### Revolutionary magnetic adapters

The new magnetic system makes it easy, fast and secure to attach and detach the optical adapters. You can switch the illumination technique (for example from polarization to diffusion) or the straight view to rotary view within seconds.



### Motorized Zoom Lens

You can change the magnification simply by clicking the menu in the application without touching the lens when changing the magnification, including changing the objective. Even an operator who has never touched the lens can easily operate! In addition, automatic operation is possible, so even if the operator is not present, remote operation can be realized with the in application menu.

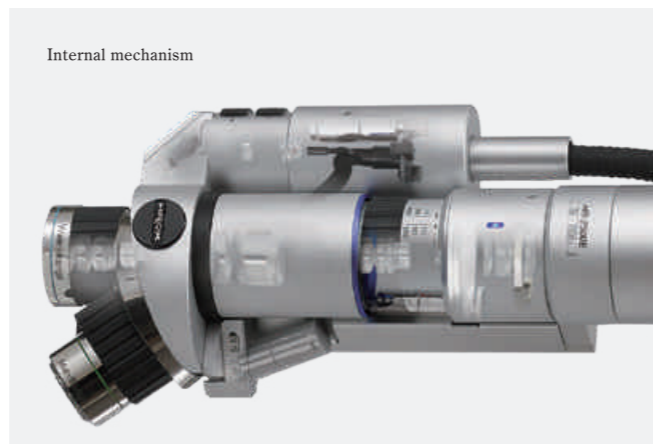

### Motorized Light Select

It is possible to automatically switch the illumination of the high-Range Motorized Zoom Lens (HR-2500E HR-5000E) that has three illumination functions:

- Bright field,
- Dark field,
- Mixed illumination.

The optimal lighting for the target can be adjusted with one click.

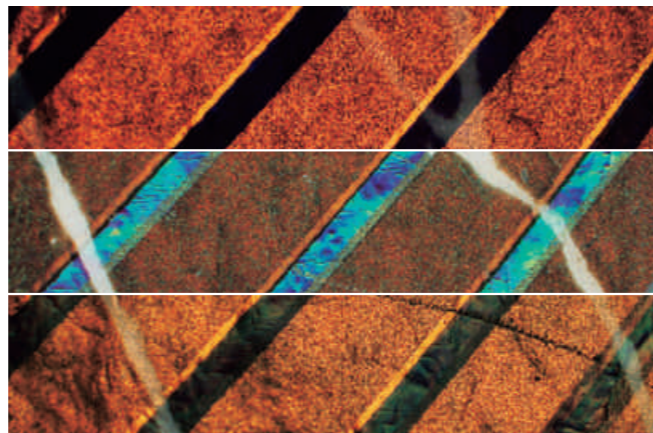

## Hirox Lens Series

	0x	20x	40x	100x	200x	500x	1000x	2000x	5000x	10000x
HR-10CE / HR-10C		35x-350x	70x-700x					140x-1400x	350x-3500x	700x-7000x
HR-5000E / HR-5000							1000x-10000x	20x-5000x		
HR-2500E / HR-2500					20x-2500x					
HR-5040E / HR-5040				50x-400x			20x-800x			
HR-2016E / HR-2016			20x-160x		6x-320x					
HR-1020E			10x-200x							
MXB-050Z		0x-50x								
MXB-MACRO		0x-20x								

※ Magnification with adapter

**Telecentric Ultra High Resolution Motorized Zoom Lens** [10-200x]  
HR-1020E



**High Range Turret (Motorized) Zoom Lens** [20-2500x]  
HR-2500(E)



**Super High Range Turret (Motorized) Zoom Lens** [20-5000x]  
HR-5000(E)



**Low Range (Motorized) Zoom Lens** [20-160x]  
HR-2016(E)



**Middle Range (Motorized) Zoom Lens** [50-400x]  
HR-5040(E)



**High Resolution (Motorized) 10x Zoom Lens** [35-10000x]  
HR-10C(E)



**Macro Zoom Lens** [0-50x]  
MXB-050Z



**Macro Lens** [0-20x]  
MXB-MACRO



# Hirox Lens Series

## Telecentric Ultra High Resolution Motorized Zoom Lens 10-200x

### HR-1020E

Hirox developed a new and unique telecentric zoom lens covering a wide zoom range from 10x to 200x with accurate measurement results. This high resolution motorized lens captures images with NO distortion and a wide field of view.

This lens offers ultra sharp images and can be used in combination with various illumination adapters such as diffusion, coaxial lighting, polarization and more.



- High Resolution
- Ideal for Measurement
- Perfect for 3D at Low Zoom
- Long Working Distance

Item Number	HR-1020E									
Magnification	10x	20x	30x	50x	90x	100x	120x	150x	200x	
Working Distance(mm/inch)	54(2.13)									
Horizontal View(mm/inch)	30.5(1.2)~1.52(0.06)									
Motorized Control	Zoom									

## High Range Turret (Motorized) Zoom Lens 20-2500x

### HR-2500(E)

The very popular Hirox revolver zoom lens has been updated, covering now a wider magnification zoom, from 20 up to 2500 times, for seamless observation from low to high magnification. The motorized zoom, objective change and illumination selection (bright field, dark field or mixed) offer unprecedented ease of use and performance. For more flexibility, you can choose between manual and motorized version.

## Super High Range Turret (Motorized) Zoom Lens 20-5000x

### HR-5000(E)

For high demanding customers in need of very fine details, the super high range motorized revolver zoom lens can zoom up to 5000x, with an optical magnification ratio of 250 times without need for dismantling the lens. A universal lens that supports various objects and observation scenes. And just like the HR-2500E, zoom, objective change and illumination selection (bright field, dark field or mixed) are motorized. For more flexibility, you can choose between manual and motorized version.



- Huge Zoom Ratio
- From Low to High Magnification
- Multiple Built-in Lighting
- Perfect for 3D at High Zoom

Item Number	HR-2500E				HR-2500			
Magnification	Wide-Range	20x	30x	50x	80x	120x	140x	
	Mid-Range	140x	200x	400x	600x	800x	1000x	
	High-Range	350x	500x	1000x	1500x	2000x	2500x	
Working Distance(mm/inch)	Wide-Range : 18(0.71) / Mid-Range & High-Range : 10(0.39)							
Horizontal View(mm/inch)	15.4(0.61) ~ 0.12(4.72mil)							
Motorized Control	Zoom/Turret/Light Select(Bright Field, Dark Field or Mixed)				—			

Item Number	HR-5000E				HR-5000			
Magnification	Wide-Range	20x	30x	50x	80x	120x	140x	
	Mid-Range	140x	200x	400x	600x	800x	1000x	
	High-Range	700x	1000x	2000x	3000x	4000x	5000x	
Working Distance(mm/inch)	Low-Range : 18(0.71) / Mid-Range : 10(0.39) / High-Range : 3(0.13)							
Horizontal View(mm/inch)	15.4(0.61) ~ 0.06(2.36mil)							
Motorized Control	Zoom/Turret/Light Select(Bright Field, Dark Field or Mixed)				—			



# Hirox Lens Series

## Low Range (Motorized) Zoom Lens 20-160x

### HR-2016(E)

This high-performance zoom lens features compact body and high resolution image covers a total magnification range from 6-320x, while offering a large optical depth of field. This lens can be used as handheld in contact or have a working distance over 130 mm depending on the adapter. The new magnetic mounting system allow quick change of adapters, including the world's famous Hirox Rotary Head, covering a very wide range of applications.



Item Number	HR-2016E				HR-2016			
Magnification	20x	30x	40x	50x	80x	100x	130x	160x
Working Distance(mm/inch)	44(1.73)							
Horizontal View(mm/inch)	15.4(0.61)~2.0(0.08)							
Adapter Recognition	Yes							
Motorized Control	Zoom/Rotary-Head				Rotary-Head			

※By Attaching Low-Magnification / High-Magnification Adapter to lens, it covers magnification range of 6-320x, changes field of view and working distance.

## Middle Range (Motorized) Zoom Lens 50-400x

### HR-5040(E)

This mid range zoom lens offers a large depth of field, with a long working distance, good resolution and realistic observation unique to large aperture lenses. With a wide zoom range, this lens is for customer that needs fast and easy observation at mid zoom of objects with high altitude differences.



Item Number	HR-5040E				HR-5040			
Magnification	50x	100x	150x	200x	250x	300x	350x	400x
Working Distance(mm/inch)	54(2.13)							
Horizontal View(mm/inch)	6.1(0.24)~0.78(0.03)							
Adapter Recognition	Yes							
Motorized Control	Zoom/Rotary-Head				Rotary-Head			

※By Attaching Low-Magnification / High-Magnification Adapter to lens, it covers magnification range of 20-800x, changes field of view and working distance.

## High Resolution (Motorized) 10x Zoom Lens 35-10000x

### HR-10C(E)

With seven interchangeable objective lenses, this optical zoom lens incorporates high expandability and the highest resolution in the series, covering a magnification range of 35-10000x. A directional lighting adapter is included for coaxial vertical lighting to achieve the finest optical observation at sub-micron level.

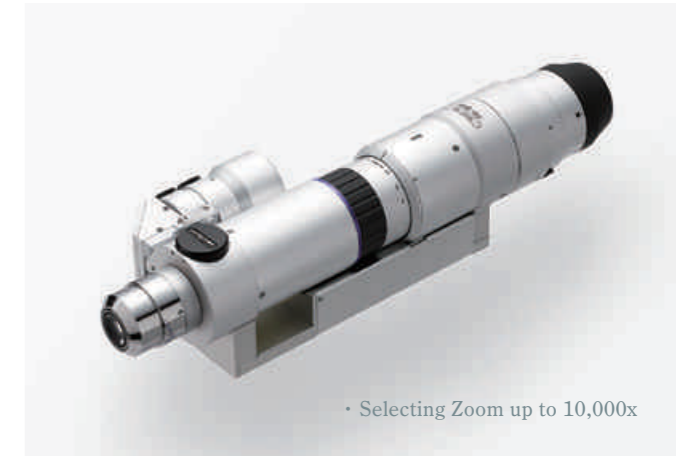

Item Number	HR-10CE							HR-10C		
Magnification	OL-35	35x	50x	75x	100x	125x	150x	200x	250x	350x
	OL-70II	70x	100x	150x	200x	250x	300x	400x	500x	700x
	OL-140	140x	200x	300x	400x	500x	600x	800x	1000x	1400x
	OL-140II	140x	200x	300x	400x	500x	600x	800x	1000x	1400x
	OL-350II	350x	500x	750x	1000x	1250x	1500x	2000x	2500x	3500x
	OL-700II	700x	1000x	1500x	2000x	2500x	3000x	4000x	5000x	7000x
	OL-1000	1000x	1500x	2000x	3000x	4000x	5000x	6000x	8000x	10000x
Working Distance(mm/inch)	OL-35:34(1.34) / OL-70II:21(0.83) / OL-140:30.5(1.2) / OL-140II:12(0.47) / OL-350II:10.6(0.42) / OL-700II:3.4(0.13) / OL-1000:1.0(0.04)									
Horizontal View(mm/inch)	9.83(0.39)~0.04(1.18mil)									
Motorized Control	Zoom							—		

## Macro Zoom Lens 0-50x / Macro Lens 0-20x

### MXB-050Z / MXB-MACRO

Perfect for observation and documentation of large objects. The MXB-Macro is using available light with a zoom depending on the working distance, giving very good results at affordable price, while the MXB-050Z offers built in ring light and calibrated zoom for advanced macro observations up to 50x.



Item Number	MXB-050Z							MXB-MACRO	
Magnification	0-5x	5x	10x	20x	30x	40x	50x	0-20x	
Working Distance(mm/inch)	infinity-90(3.54)							—	
Horizontal View(mm/inch)	∞~61(2.40)							infinity~15.4(0.61)	

# Hirox Accessory Series

## Rotary - Head



It enables observation of an object in 360 degrees of rotational inspection, with a 45 degree and various viewing angle. Through the observation of the moving object, the object's shape is better understood.

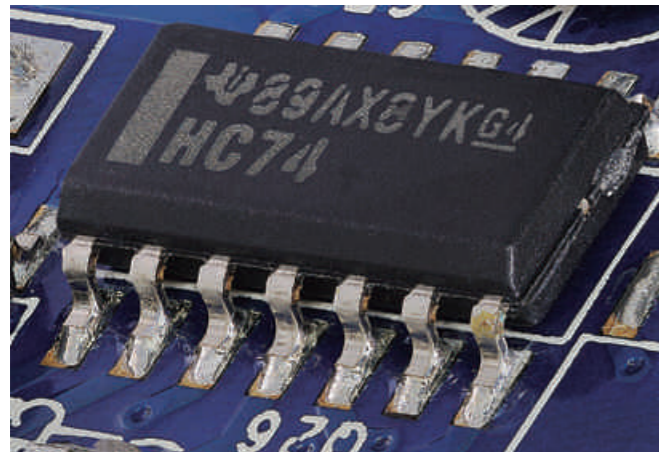

PCB Soldering

## Diffused Lighting



This adapter diffuses the light in all directions and creates soft illumination. Thanks to the multi directional lighting, the light is evenly distributed on the objects, reducing strong reflections. It is suitable for observing metal surfaces for example.



Motor

## Low/High magnification Adapter



Low-magnification Adapter reduces the lens magnification while increasing the working distance enabling the inspection of larger objects/area. High-magnification Adapter doubles the lens magnification, enabling the inspection of smaller objects/ area.



Magnetic Head for HDD

## Transmitted Polarized Lighting



Using a filter with the condenser, light can be restricted to a single direction of vibration. This filter can enhance an image by reducing light intensity and glare. This is especially useful with transparent biological samples, as different elements/features of the sample can be observed by changing the direction of the light.

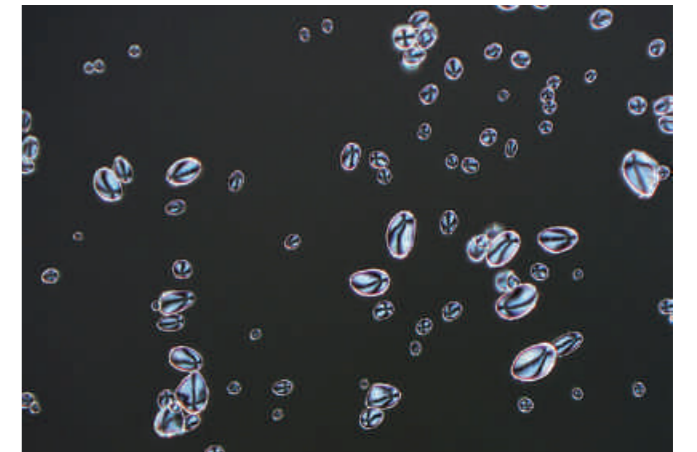

Starch Particles

## Variable Lighting



This adapter allows the illumination angles to change freely from epi-illumination to side illumination. It helps to find the optimal illumination angle for the best observation. This is an original Hirox design.



Fabric

## Polarized Lighting



This adapter helps to reduce the reflection of the surface from the observed objects through polarizing filters. It is particularly effective for printed matters, substrates, coatings and other objects that are highly reflective.



Weld Penetration

## Co-Axial Lighting



Observation through lighting that is parallel with the lens axis can be difficult to ascertain and inspect intensely reflective surfaces. With this adapter, the light is reflected perpendicular to the lens axis.

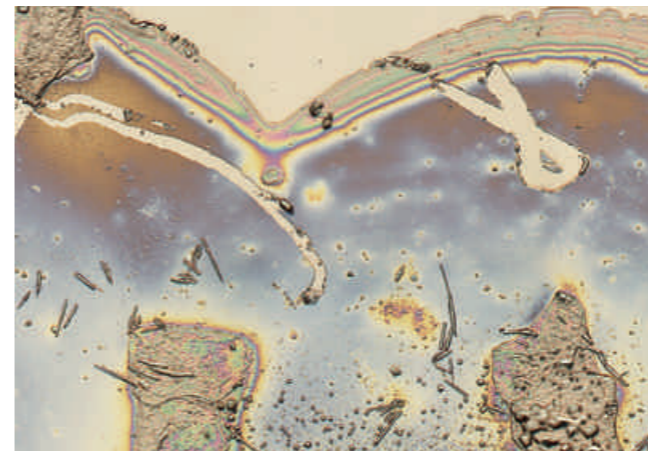

Dirt Of HDD Platter

## Handheld Observation



Sometimes it is necessary to observe a large object that cannot be placed on the stage, such as inspection of wheels, paint on the car body surface, or a person's skin.



Front Bumper Of Automotive



# NEW High Precision Free Angle Stand

## Precision control of 0.05um

Hirox created a completely new inclination stand featuring multiple integrated sensors and a high precision 80 mm motorized Z movement, providing the highest level of accuracy for various applications.

The XY stage can be motorized (50x50mm or 100x100mm) for automatic XYZ acquisition, or manual. The stand also integrates built-in transmitted illumination, controlled by the HRX-01 software, increasing the observations capabilities, as well as antivibration feet for improved stability. Thanks to various sensors - including height and angle - the ST-AS stand truly supports the users, offering intelligent & stress-free observation.

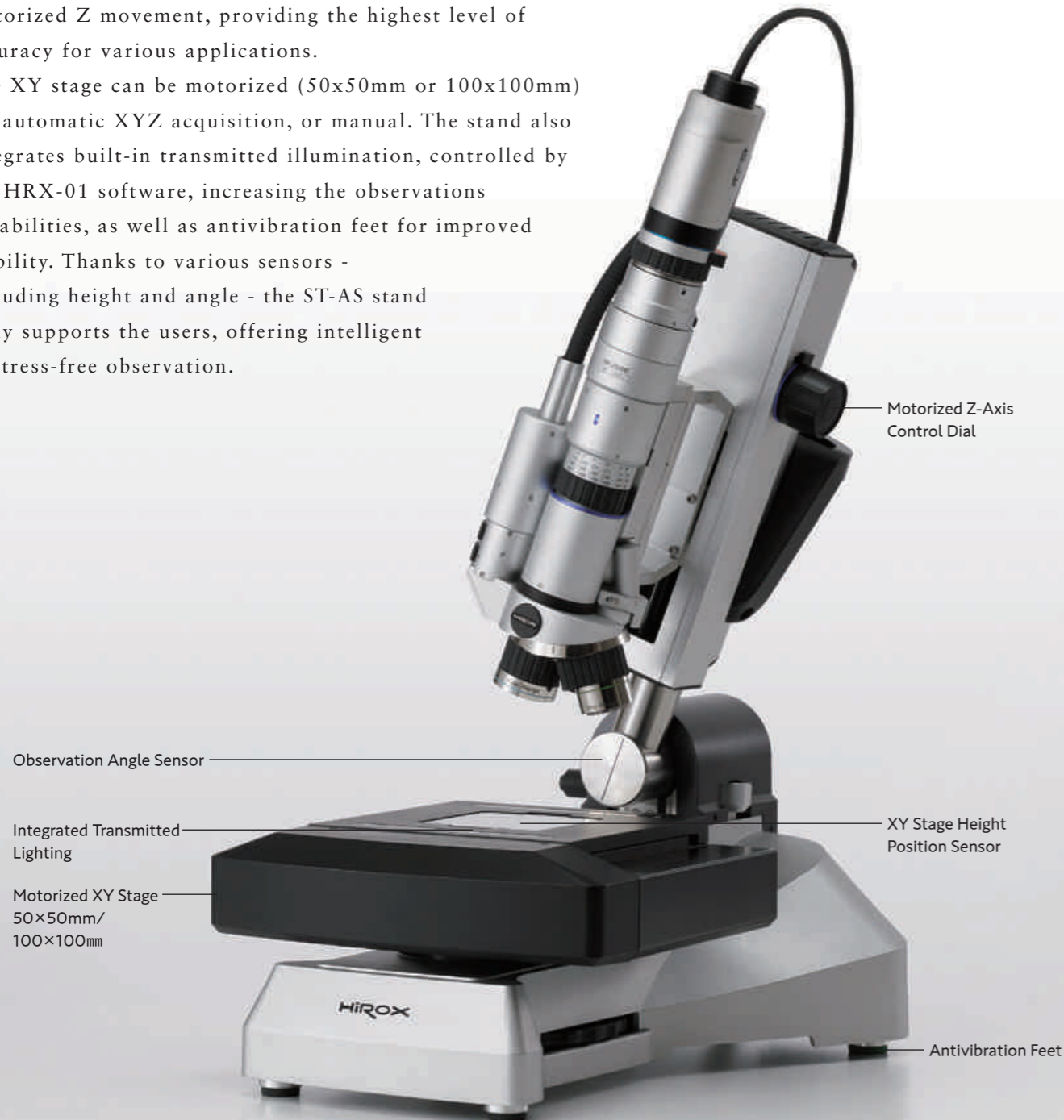

### Motorized XY-Axis Large stage

Large Motorized XY-Axis Stage allows for the observation of large samples with effective stroke of 100mm x 100mm . High intensity LED transmitted lighting is built in for observation of various samples.

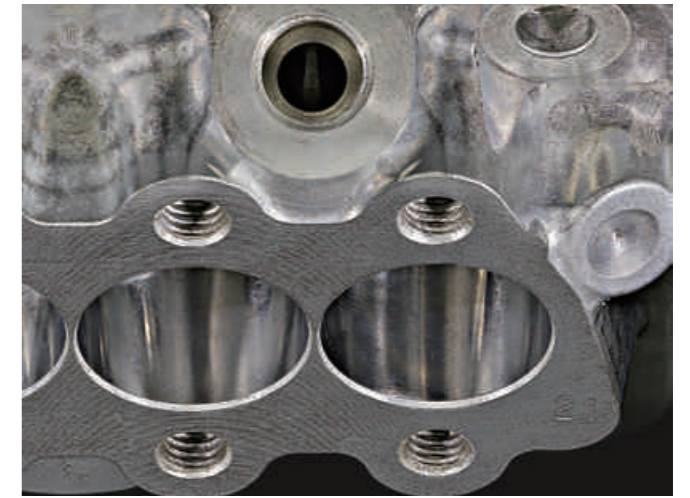

Cylinder

### Multiple Lighting Capability

The ST-AS stand can expand lighting options, such as transmission illumination, but also it allows controllable additional external lighting such as the newly developed dual side lighting option, offering higher flexibility of observation.

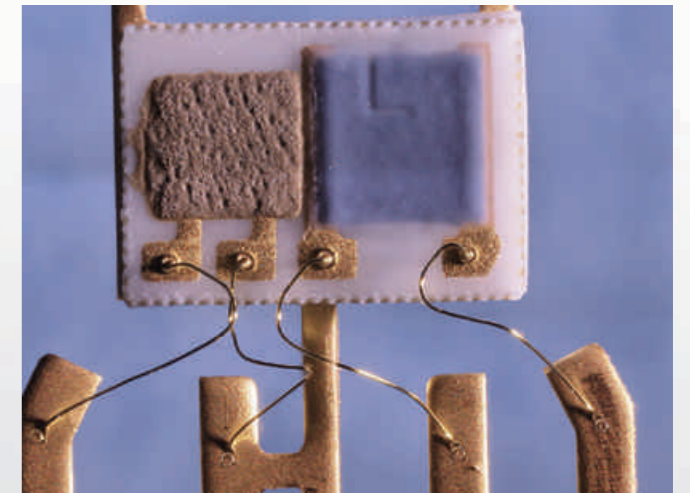

Component part

### Rotation Stage

Rotation stage effective for wafer observation can be attached. It fixed 4inch, 5inch 6inch sizes by digging. Sizes over 8inches are also available.



Wafer

# Selectable Digital Microscope System

Hirox reviewed all of the camera, lenses, and stand, and newly designed and developed a complete set of digital microscope systems.

In order to respond more precisely to the user's application, we have a lineup of two models, a flagship model and a standard model, each of which has a function that can be selected according to the application.



## HRX-01

### Flagship model

With the new HRX-01, Hirox keeps on leading the way for 3D Digital Microscopes! Hirox completely redesigned its successful PC based system with new high resolution camera, a newly developed intelligent stand combined with high end motorized lenses-bringing digital microscopy to a completely new level. Fully packed 4K system with multiple included functions such as advanced 2D measurement or 3D visualization that can be customized with 3D measurement, tiling and contamination.

## RX-100

### Standard model

The RH-100 is based on the HRX-01 model, it is designed as an entry level system with adjusted resolution but without losing software features! With an attractive pricing, the RH-100 is using the resolution. Fully compatible with the new stand ST-AS, it is using the same high quality lenses in manual version.

Model	Basic System System with basic functions of Digital Microscope		3D Measurement System For those who often observe uneven shapes and 3D measurements		Tiling System For those who often observe high resolution and wide field of view		Full System For those who want to observe a wide variety of samples in various ways	
	HRX-01	RX-100	HRX-01	RX-100	HRX-01	RX-100	HRX-01	RX-100
2D Measurement	●		●		●		●	
3D Measurement			●				●	
Tiling <sup>※2</sup>					●		●	
Motorized Zoom	●	▲ <sup>※1</sup>	●	▲ <sup>※1</sup>	●	▲ <sup>※1</sup>	●	▲ <sup>※1</sup>
PC Monitor	4K	Full HD	4K	Full HD	4K	Full HD	4K	Full HD

※1 : HR-1020E can be connected to RX-100.  
 ※2 : Motorized XY-Axis Stage is required





# Sample Image

Electronics / Electric / Semi

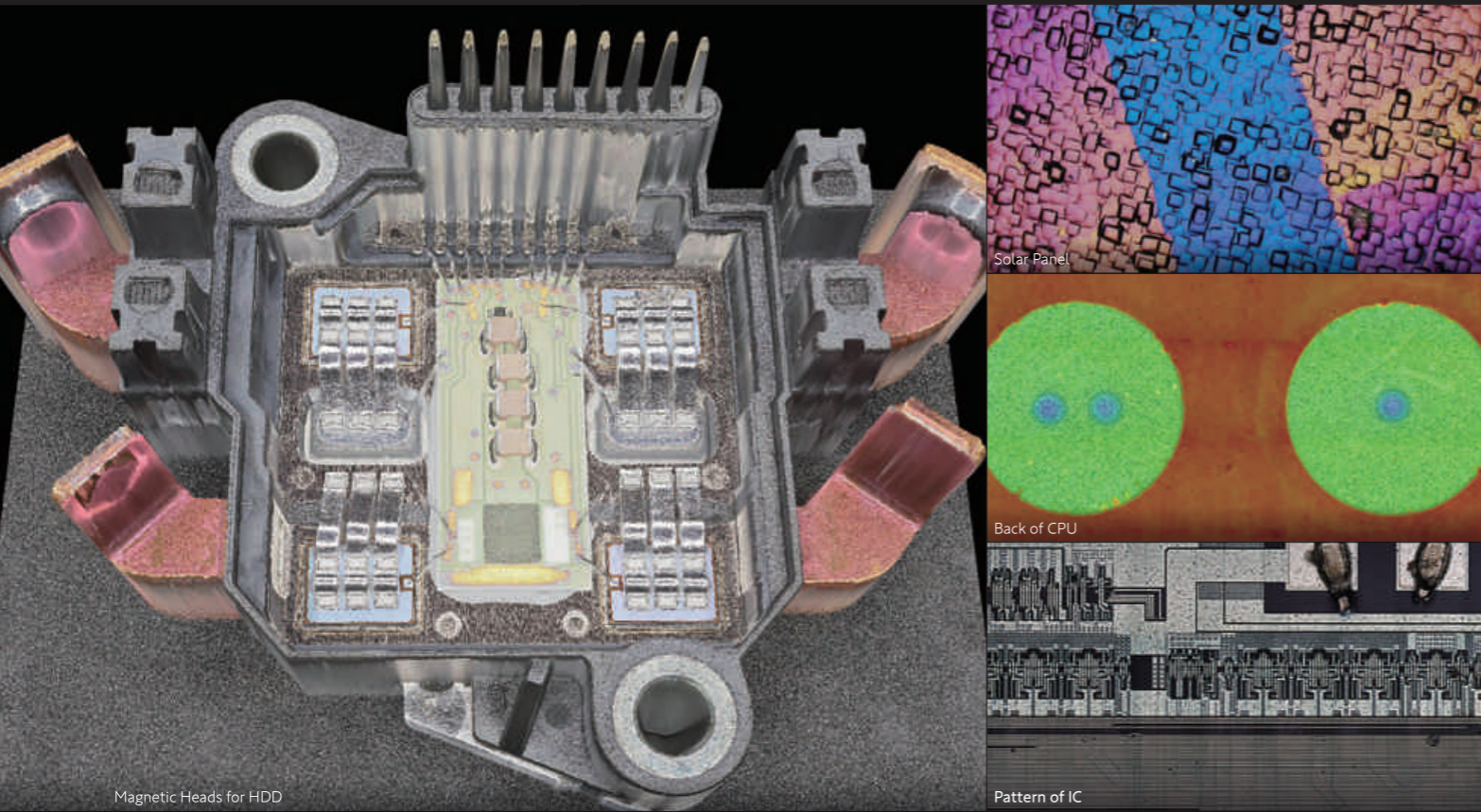

Chemical / Medical / Pharma

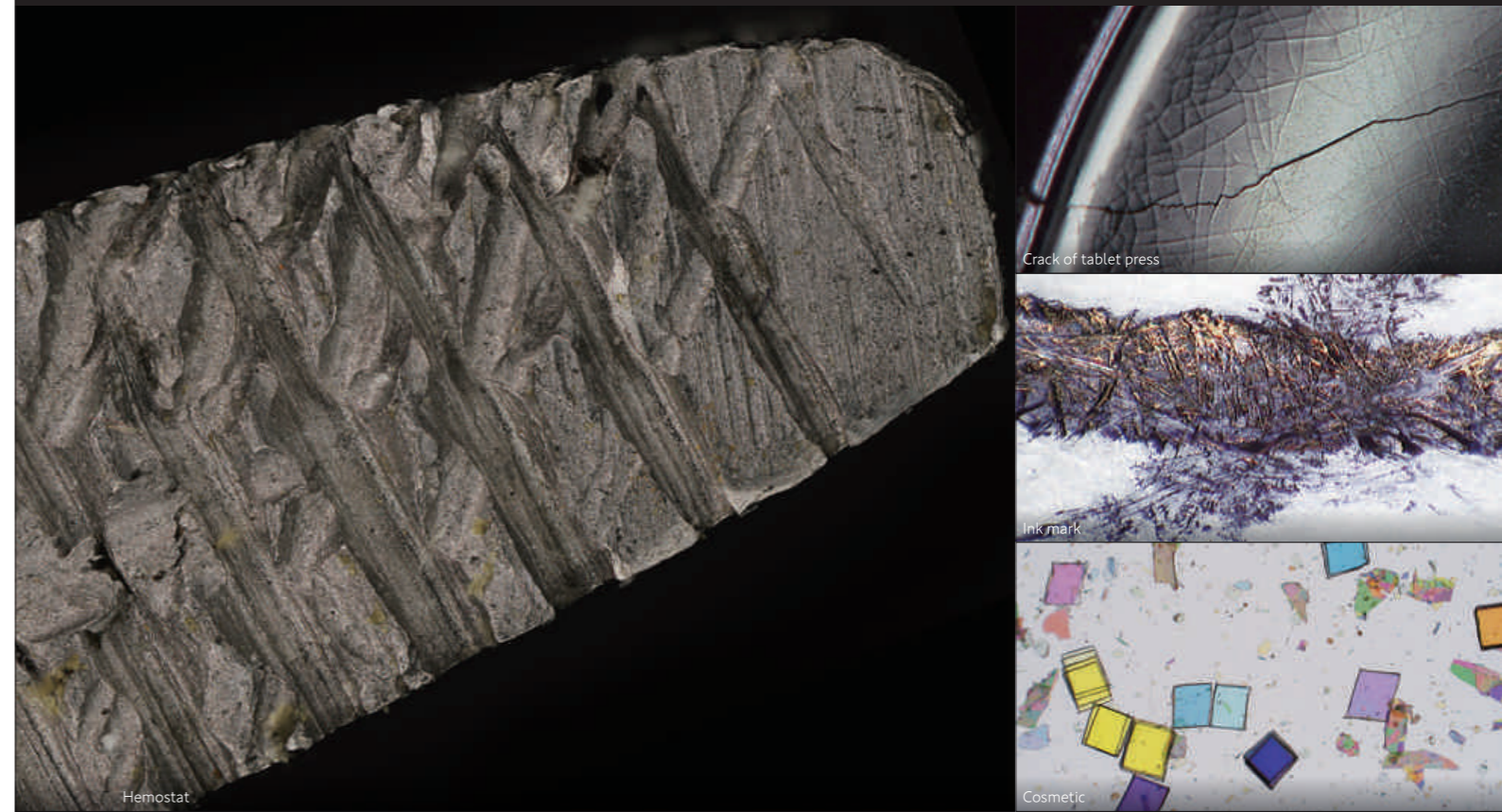

Automotive / Metal / Machinery

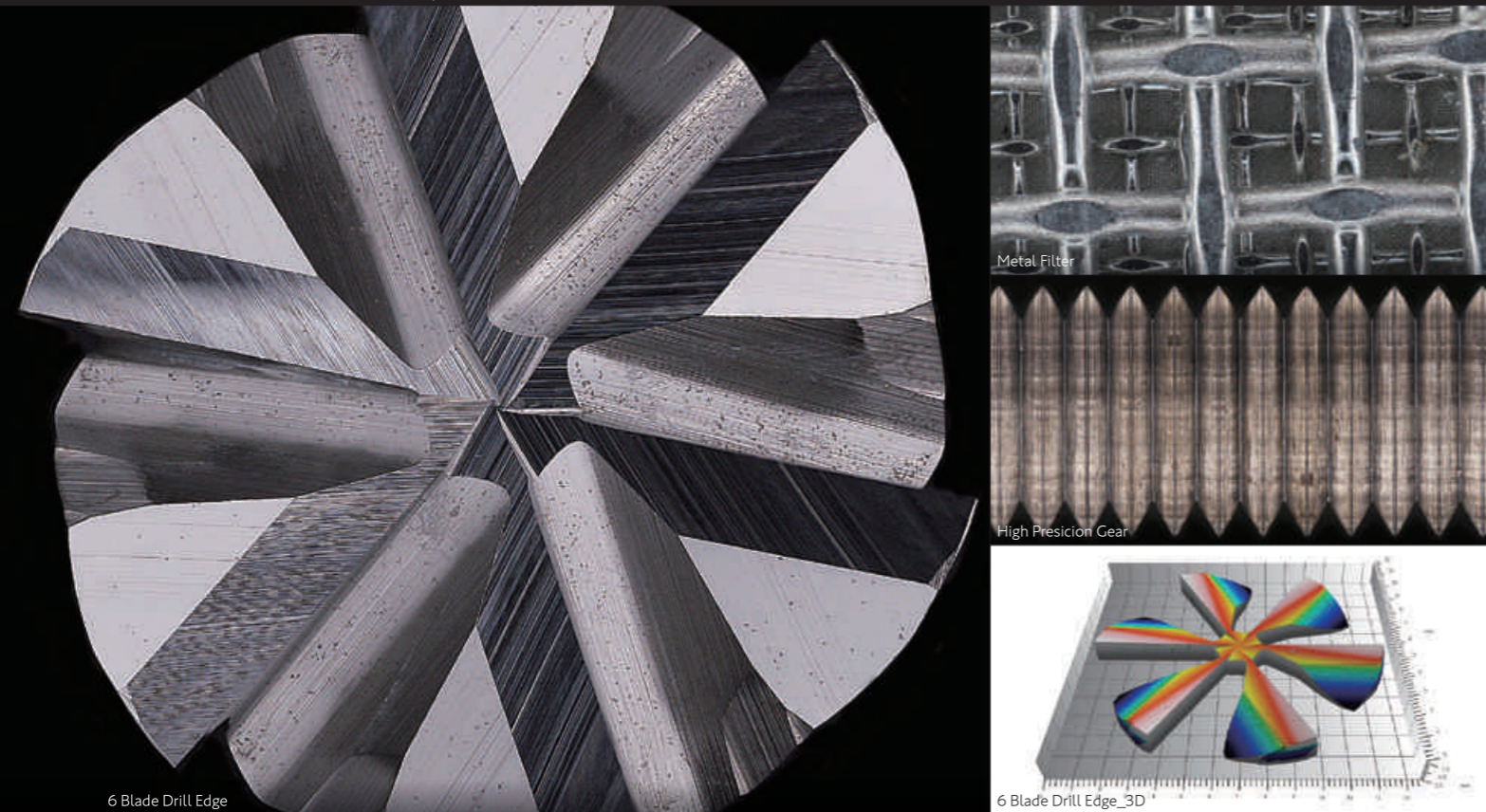

Bio / Agriculture / Food





# Observation

Ultimate Observation  
Performance Pursued  
With a New Camera and  
Lens

## Live-Focus

This standard function instantaneously creates a fully focused image of the area even for objects with high differences in height. Anyone can easily perform this expanded observation without being limited by the depth of field.

Butterfly Wings

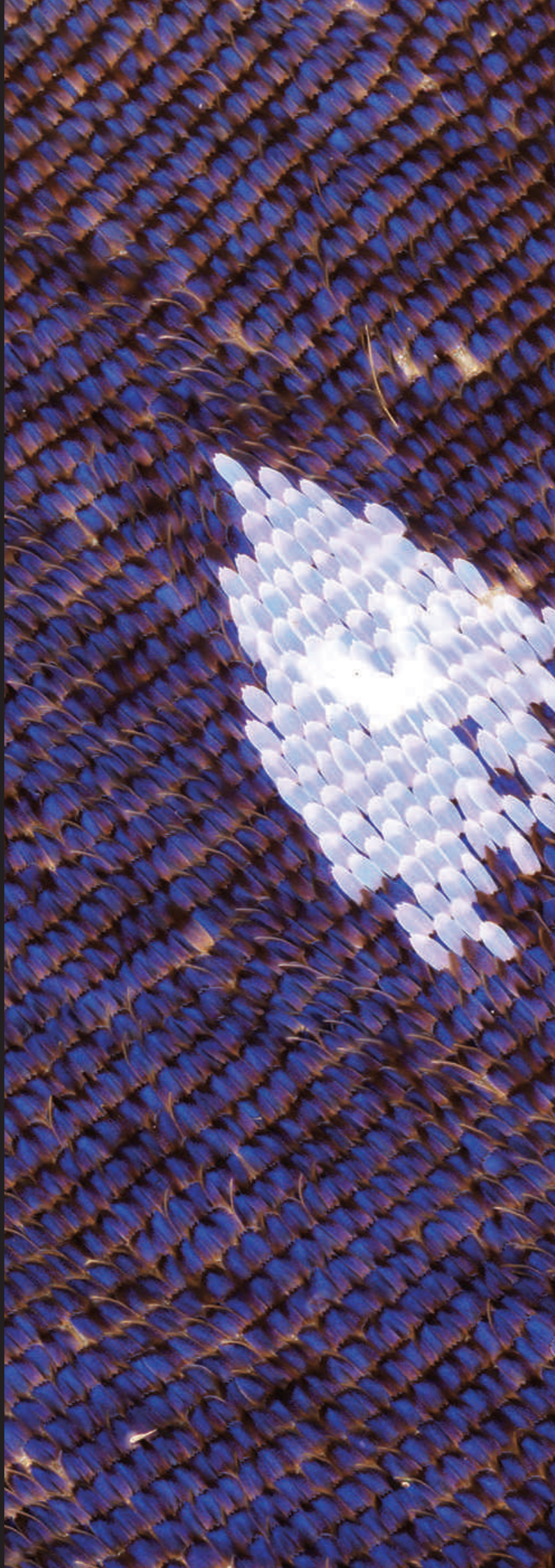

## Live HDR & Automatic Optimization of Live Images

The HRX-01 artificial intelligence automatically select the optimal observation settings according to the observation scene and object.

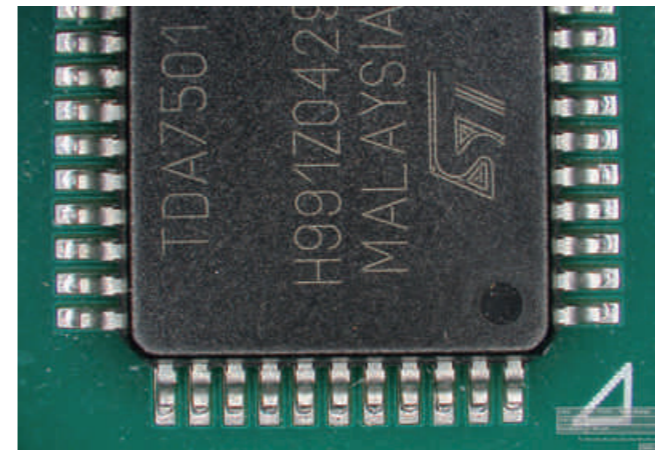

QFP

## Patented Motorized 360o Rotary Head inspection

Switch the optimal camera settings for real-time images with one click. We also provide detailed shooting settings for users who need subtle color adjustments.



Connector

## Restore Cam Settings

The observation conditions of saved images can be reflected in the observation conditions of real-time images. It is possible to always observe and shoot under the same conditions when the target is the same system as the one shot in the past.

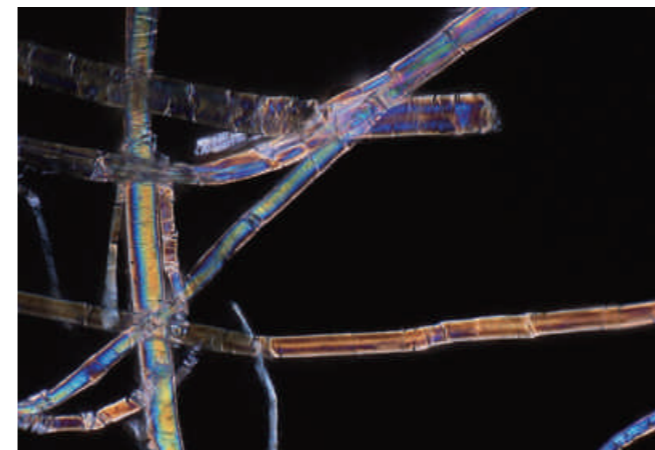

Blond Hair

## Guide Map

The captured image becomes a guide map linked with the position information of the electric XY stage. By using a low-magnification image as a map, you can see at a glance which position you are observing even when the field of view is narrowed at high magnification.

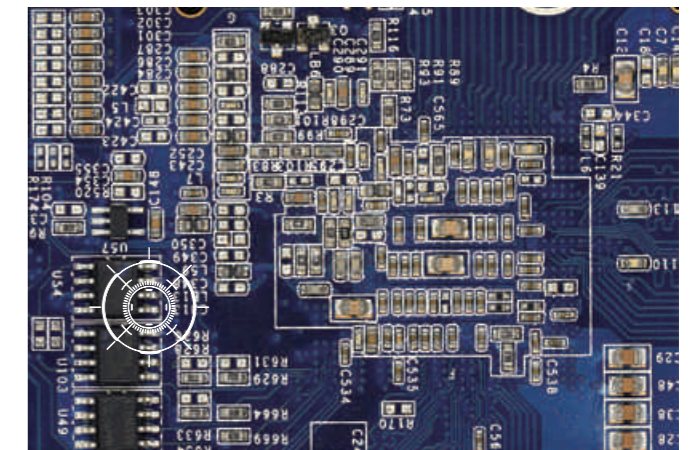

Mounted Board



# Recording

High-quality  
Recording the shape  
and texture of an  
object as it is

### High-Quality Image Capture

It can capture a still image in different formats (TIFF / BMP/ JPEG). Every saved JPEG image is ingrained with the camera, calibration, and magnification information, allowing for confirmation of recording date, camera settings, and intensity of light used. It can record video for up to 200 minutes.

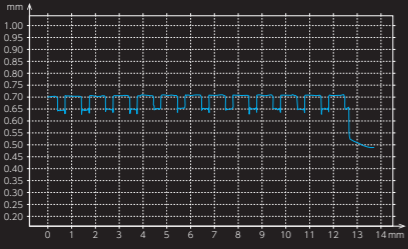
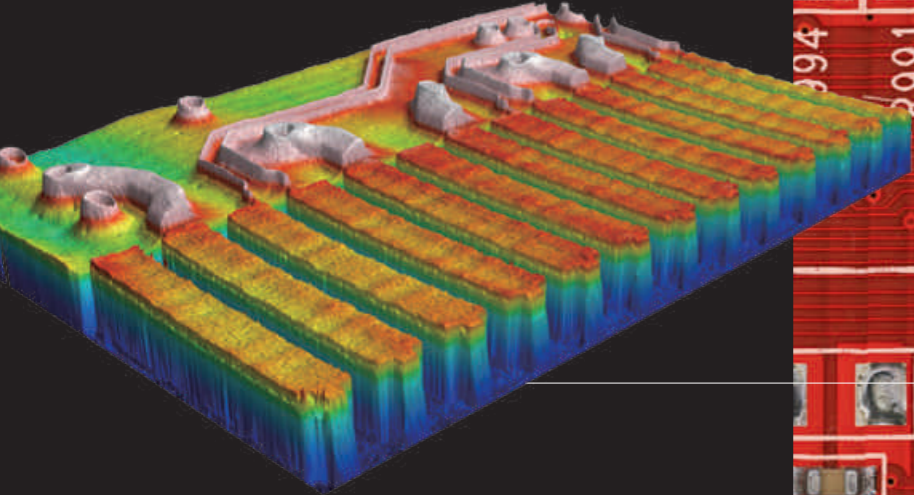

Mounted Board

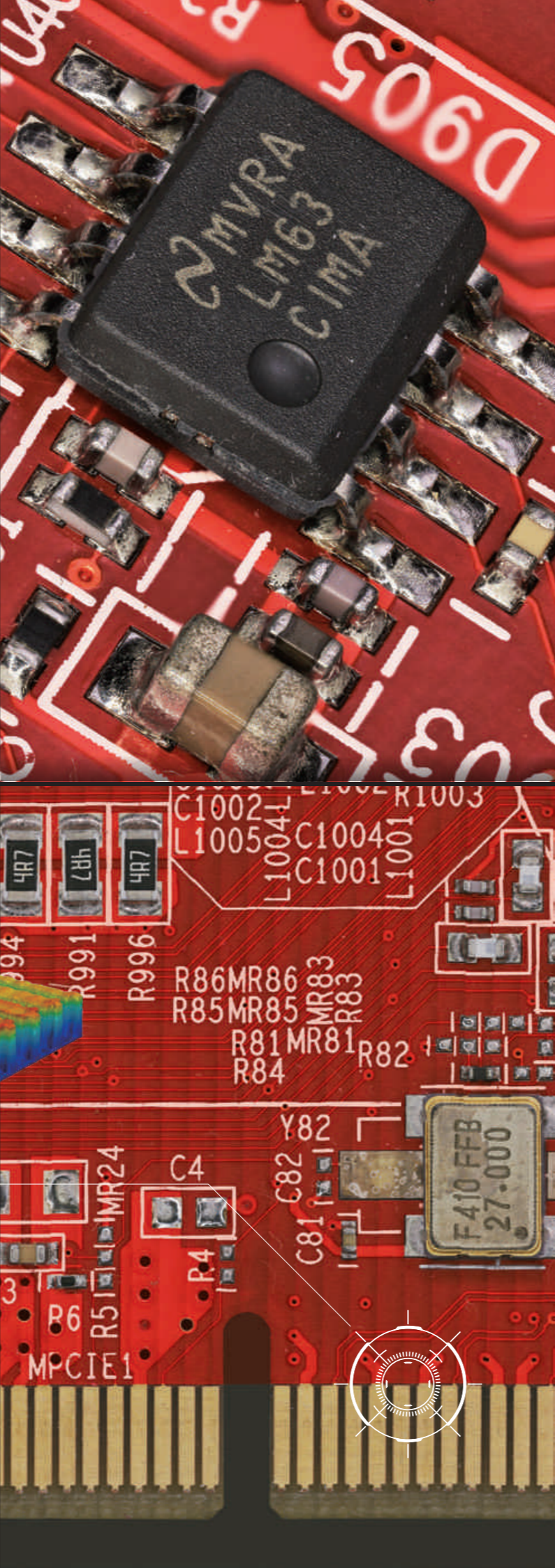

### Image Tiling

Just select the area of interest and the image will automatically begin stitching seamlessly in real-time with the motorized XYZ stage creating amazing high optical resolution images with a wide field of view simultaneously. And with the “map” function, the tiled image is displayed on the screen so you just need to click on the map to bring the stage to the clicked position.

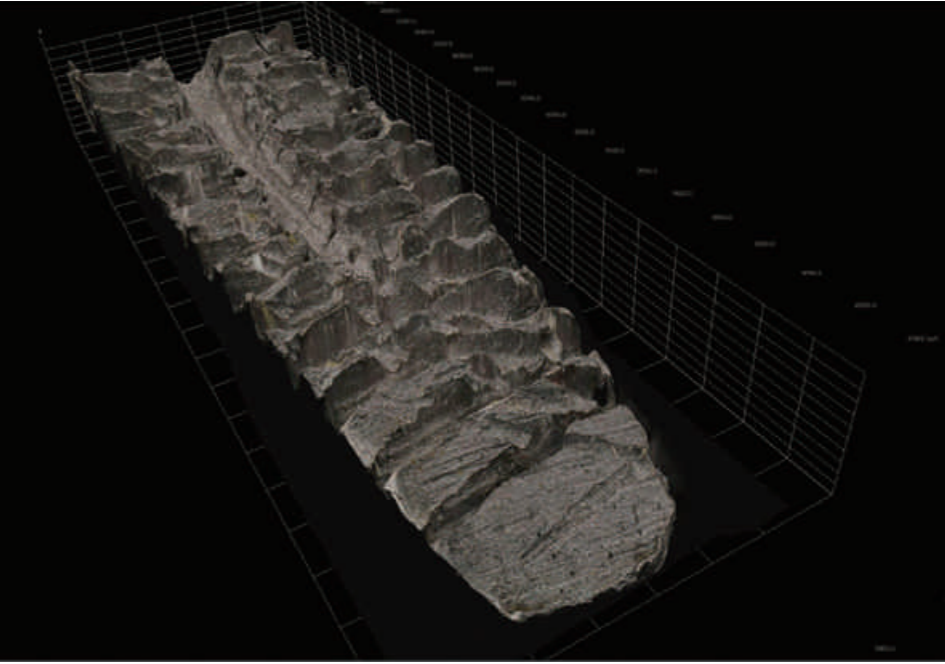

Scratches on Metal

### Coordinate Capture

It automatically moves to the XY coordinate values registered in advance and record one after another. The auto-focus function makes it possible to take pictures with clear focus.



Cutting Tool(Drill)

### Time Lapse Recording

The HRX-01 RX-100 can automatically take a sequence of frames at a specified interval to record changes over a set duration. To help reduce energy consumption, the LED lamp is only turned on when necessary.

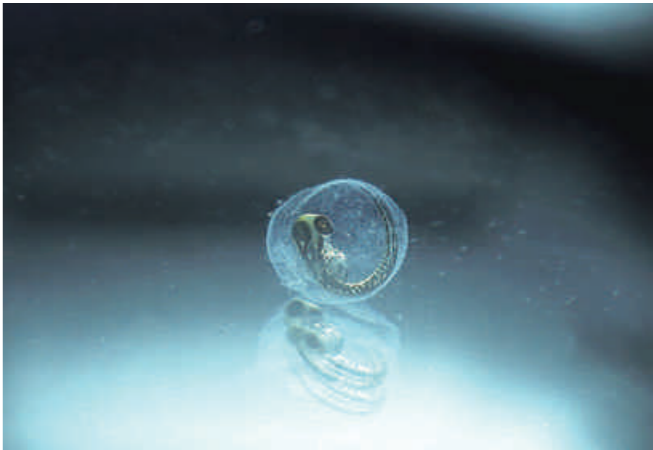

Egg of Zebrafish



# Measurement

Intuitive Measurement Software enables accurate results in a wide range of applications

## Various Measurement Application

In addition to observing an object in high resolution, it's now easy to measure exact dimensions and height of any parts. We support a variety of practical and easy-to-use measurement tools such as 3D measurement of depth, height, volume, as well as 2D measurement of the length, angle, area, and radius of the object.

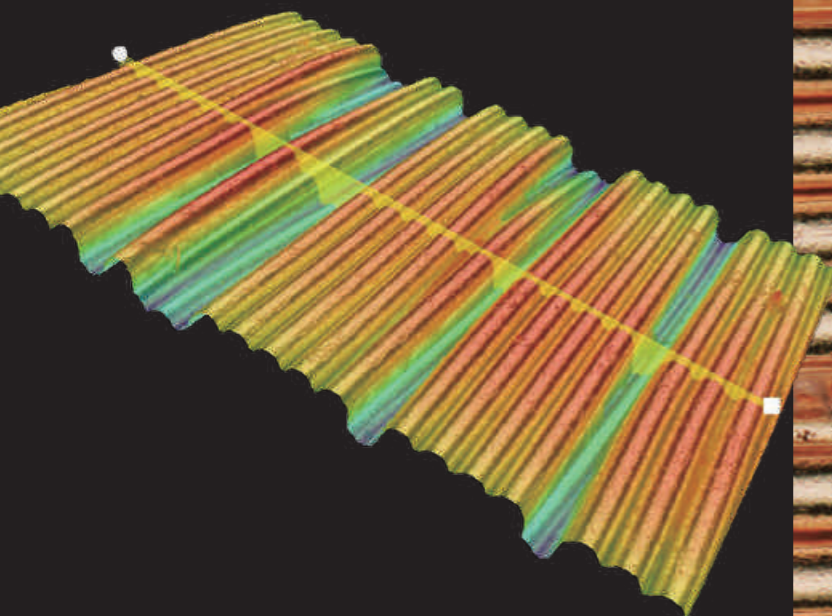

Coil



## Roughness(Ra, RZ)

The powerful 3D software enables accurate line roughness measurement in Ra and Rz (ISO4287:1997) and is compatible with optional surface roughness measurements (Sa, Sq, and many more).

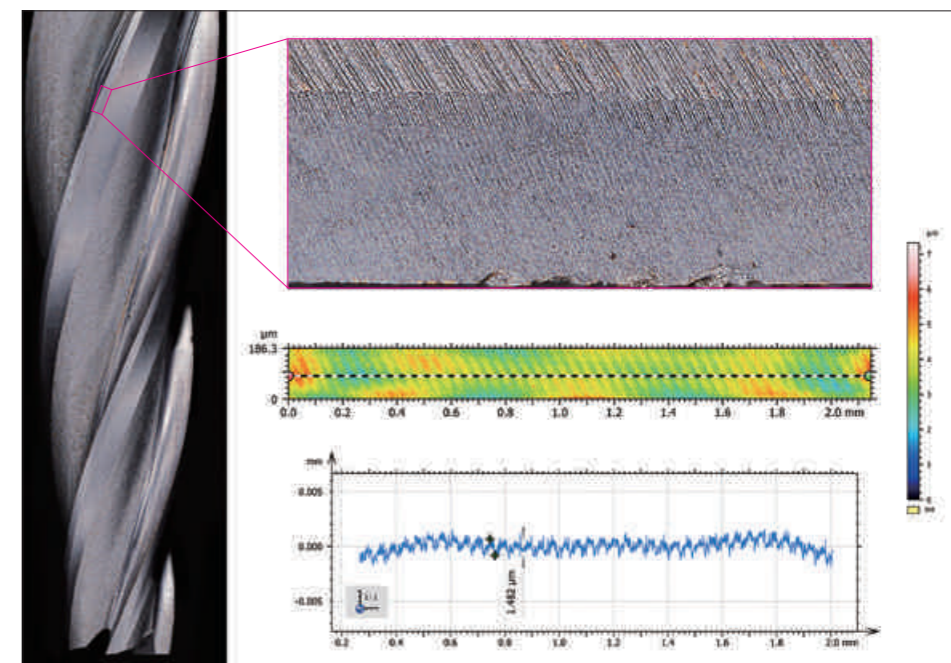

Blade Tip of Drill

## Auto Count Functions

Advanced software algorithm allows automatic detection and count of particles, based on contrast or color values. With 1 click the system automatically counts parts that have similar colors, with Advanced statistics.

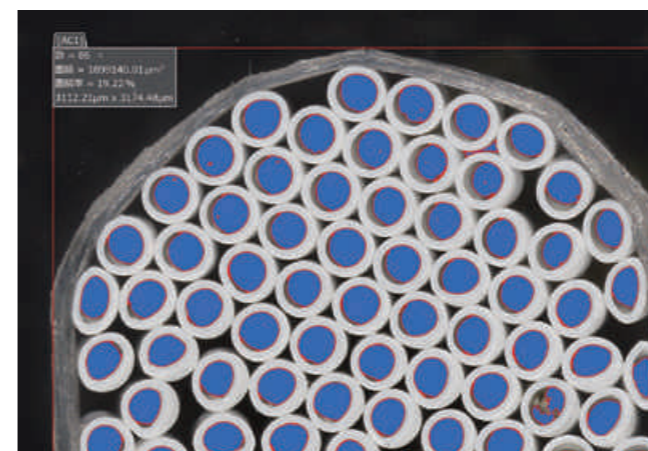

Hollow Yarn

## Volume and Area

Volume and area can also be measured on the 3D object by adjusting the horizontal cross section and clicking on the area of interest.

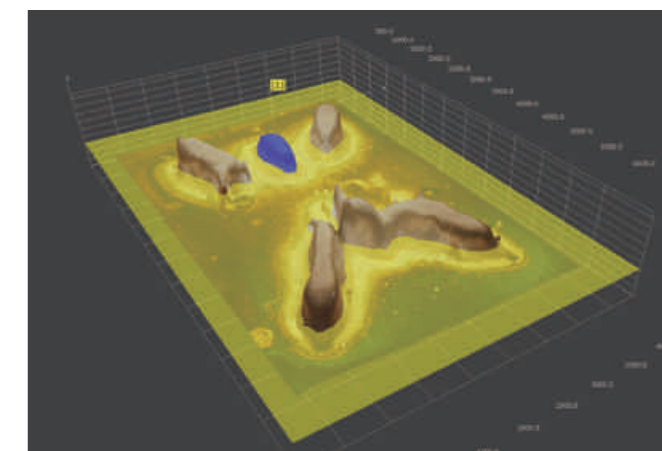

Copper Precision Parts



# Measurement

## Other Functions

### Contamination Analyzer (ISO 16232 Compliant)

Particles are automatically detected with pass/fail judgment by settable threshold. Advanced statistical data with histogram and frequency distribution are automatically calculated and displayed in Excel. It's very easy to measure the shape of every particle or cells, from metal particles to animal cells.

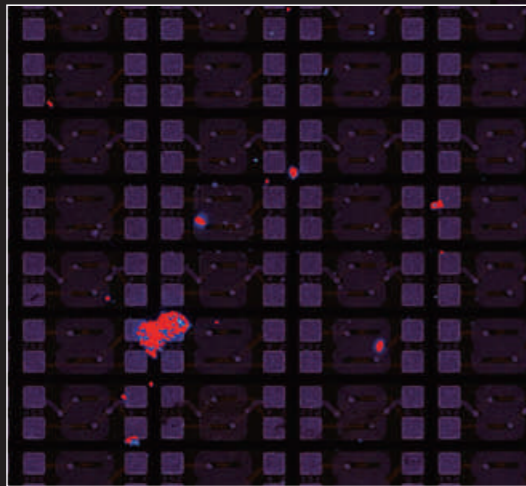
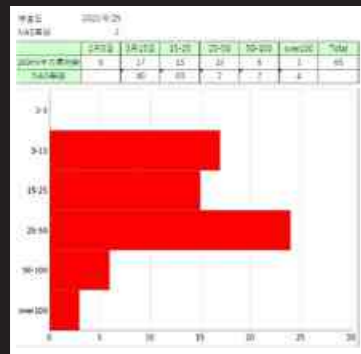

Contamination on IC Pattern

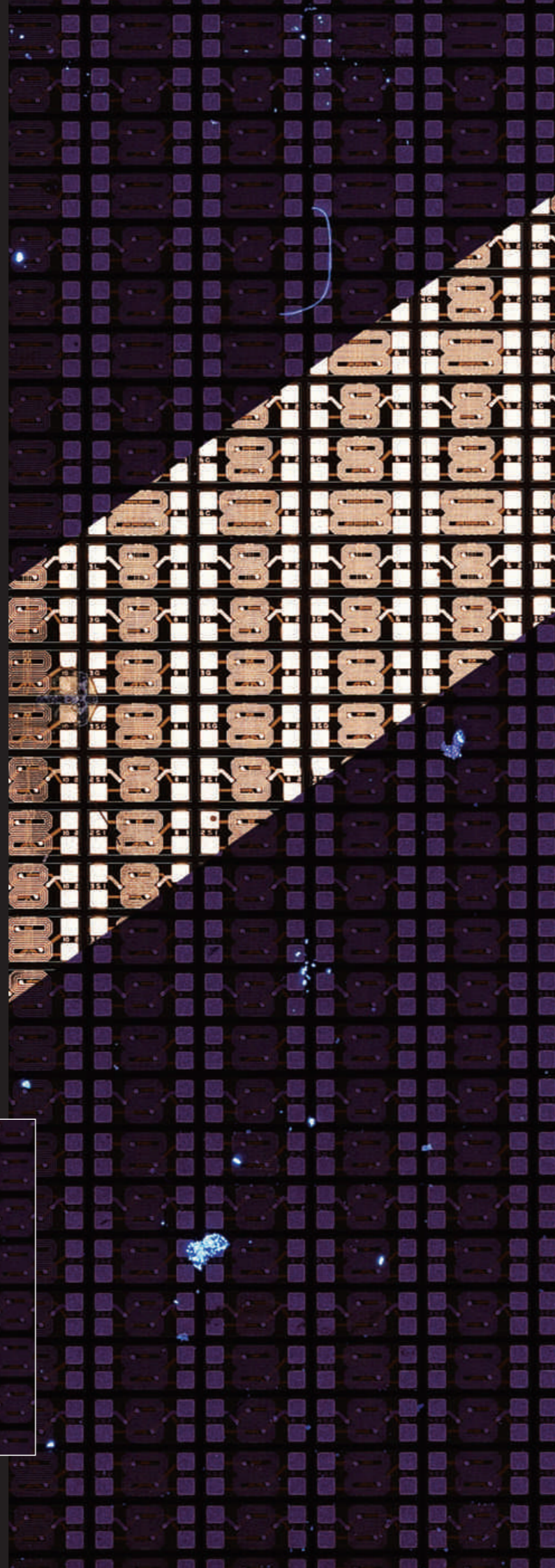

### Needle Particle Measurement

It is possible to separate each particle and measure the length, width, direction, needle shape ratio, and number of particles. This function is useful for objects such as fibers and wires which are long and thin and readily overlap each other.

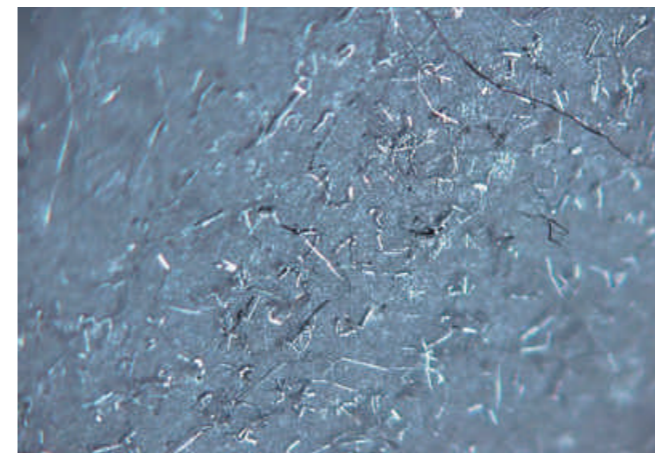

Whisker

### Metal Grain Boundary Measurement

When observing polished metal structures, particle size and area can be measured by recognizing and separating normal non-binarizable boundaries using a special algorithm.

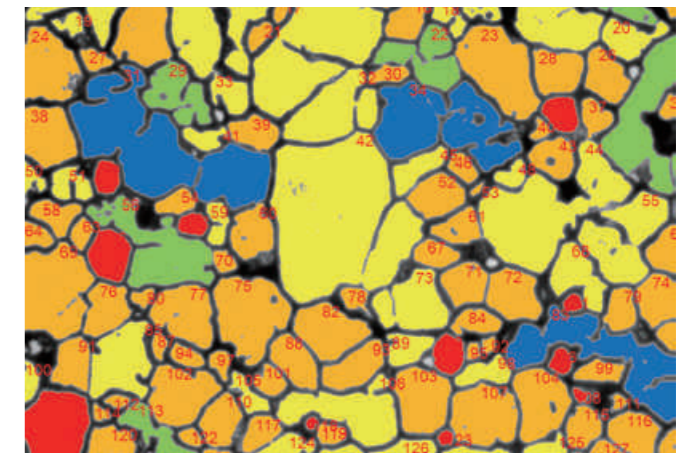

Metal Structure

### Excel Reports with One Click

This feature enables one-click export of images, measurement results, statistics & image information into an Excel sheet. The report format can be easily customized so that you can create your own report with company information. The integration between the HRX-01 and Windows is seamless and offers great flexibility.

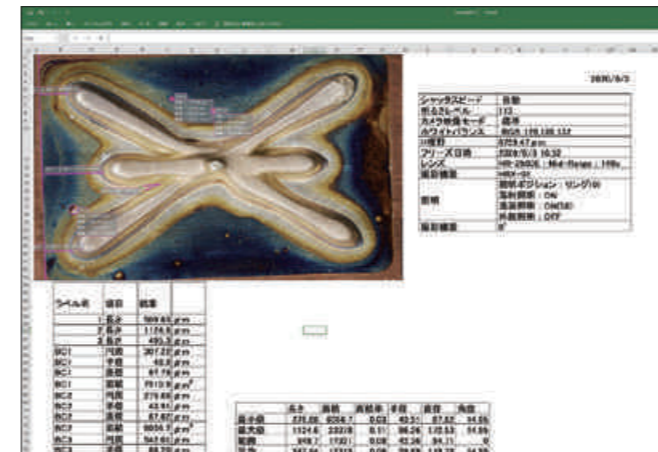

### Remote Observation

The motorized zoom lens and motorized stand system enable propose a new observation style. Regardless of the internet or company network, if you install the dedicated software on a computer connected to the network, you can perform magnification operation and stage operation from another place, and you can observe, measure, and record in real time.



※ This spread page function requires optional software separately.



# Customize Line Up

## Observe Paintings with a Digital Microscope

The HIROX EUROPE staff participated in a project to verify Vermeer's "Girl with a Pearl Earring" in the Mauritshuis Museum (NL). The project took place in the museum for two weeks and was held in a glassed space for visitors to see. In order to shoot the whole painting, we have created an XYZ 3-axis motorized stand with a very large working area (500x500mm motorized axis). The installation and real time observation of the system is available on our website, using the QR codes.



Verification landscape



Setting up Systems



Full panorama



Copyright : Mauritshuis « Girl with the pearl Earring - Johannes Vermeer »



Copyright : Mauritshuis « Girl with the pearl Earring - Johannes Vermeer »



1 Right Eye 140x

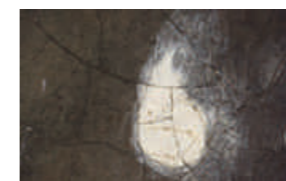

2 Earring 35x

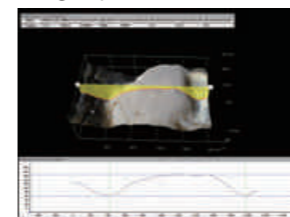

Height Measurement

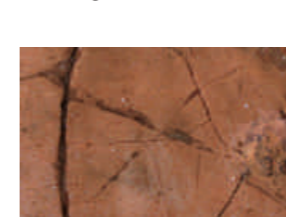

3 Lips 140x

※ The entire painting was captured at 35x with over 9,000 multi focus images. With the high quality Hirox lens, a very high resolution image with true color rendering shows very fine details that have never been seen before. In addition, we photographed 9 areas of interest, such as the eyes, earrings, blue scarf, and lips, at 140x, and converted them into 3D data to measure paint thickness and even individual pigments.

### System Configuration



## Other special stands

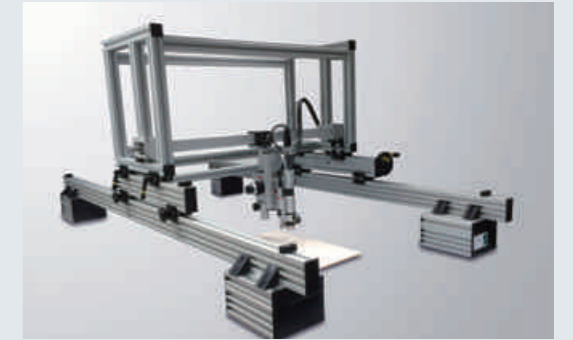

A large stand for large objects such as glass plates, large substrates, and paintings.



A portable type that allows you to observe large objects without riding on the stage.



A stand that allows you to observe a disk-shaped object from the edge to the center while rotating it. Compatible with 12 inch wafers.



Flexible arm stand that is effective for objects that cannot be placed on the stage.



# Hirox System Line Up

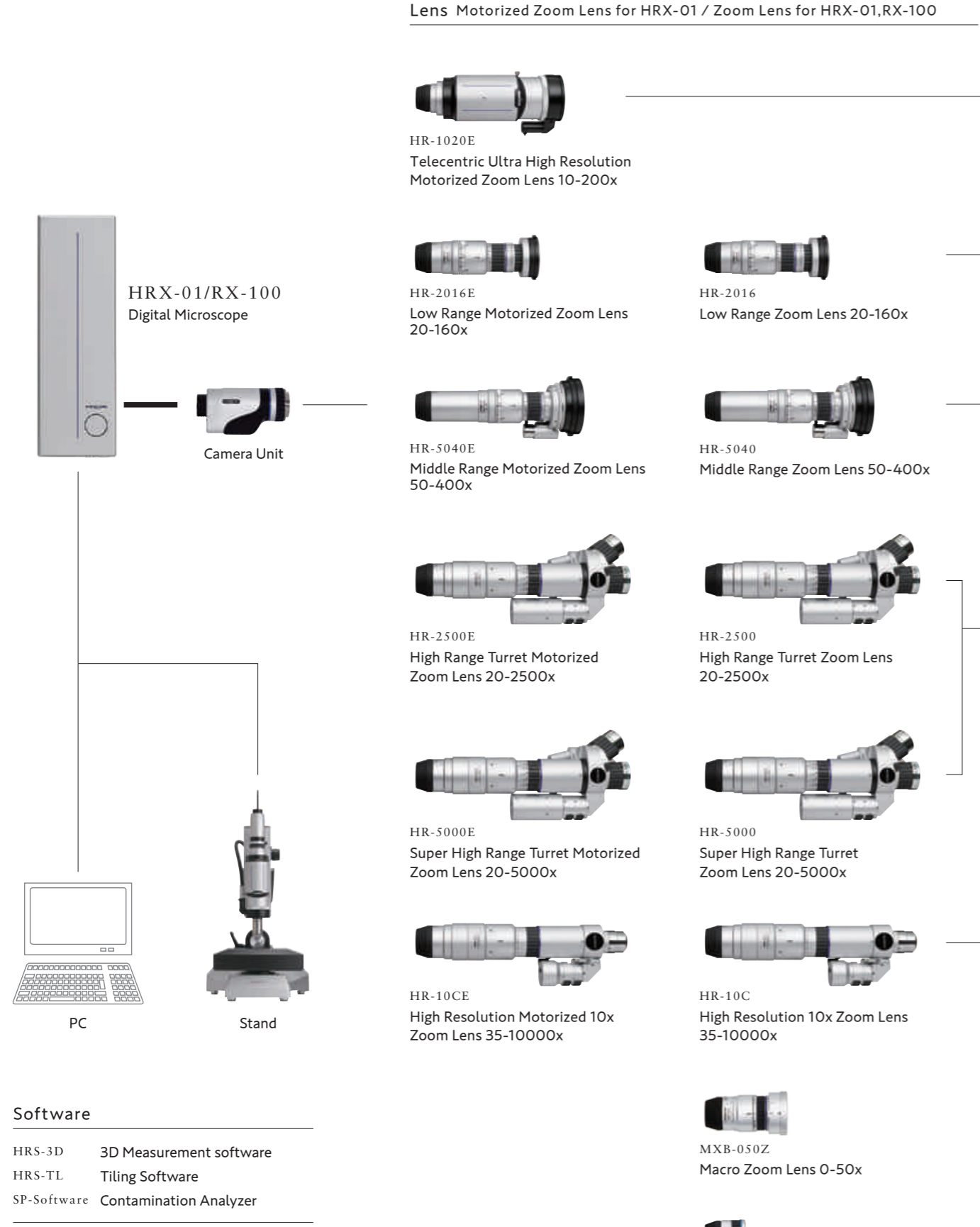

- Software**
- HRS-3D 3D Measurement software
  - HRS-TL Tiling Software
  - SP-Software Contamination Analyzer

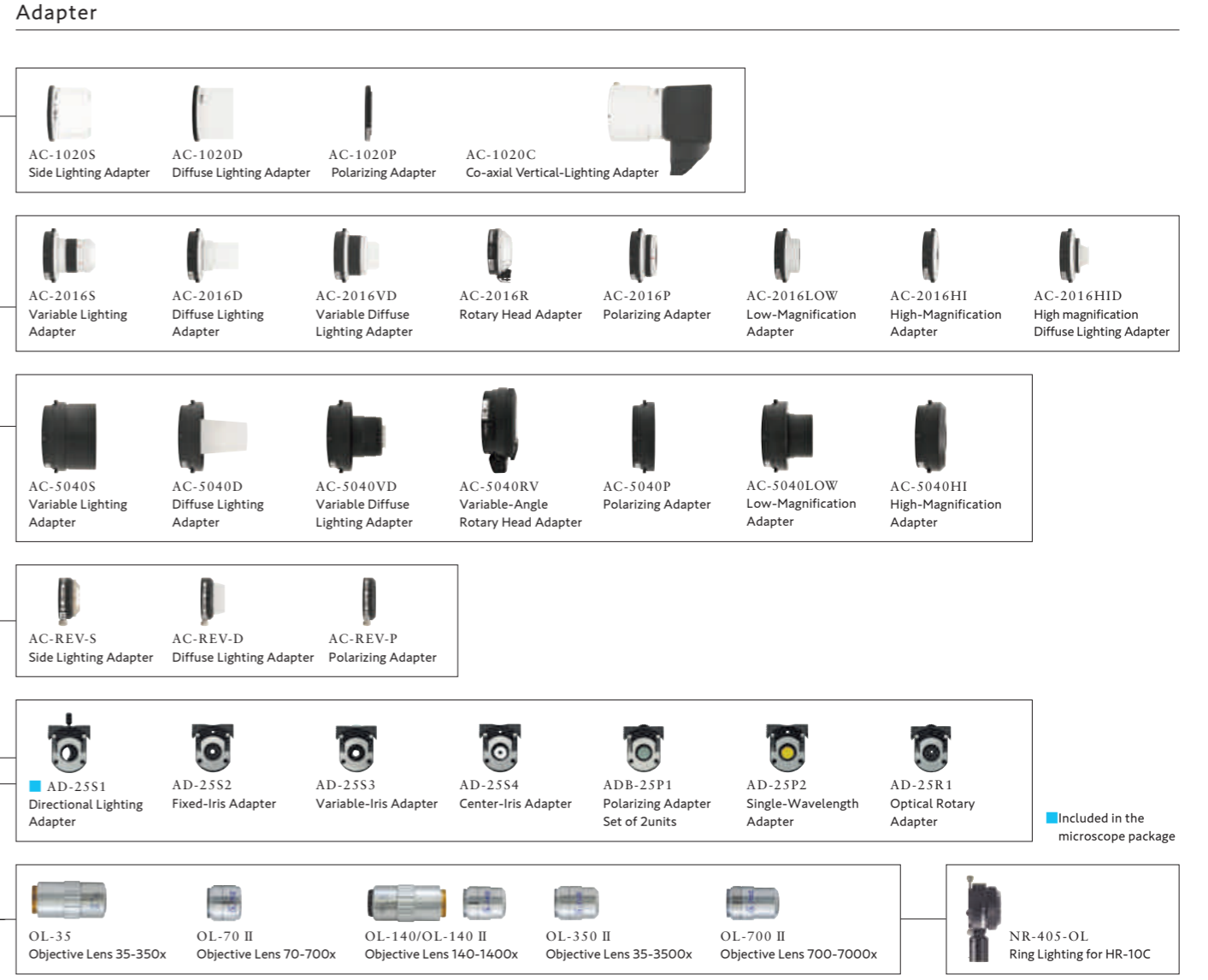

# Specification

## Basic Functions: Camera Control Unit

Model	HRX-01	RX-100	
Camera	Imaging Device	2/3-inch 5.07Megapixel CMOS Image Sensor - Global Shutter Type	
	Total Pixels	2464(H)×2048(V)	
	Effective Pixels	2448(H)×2048(V) / 2040(H)×1530(V)	2448(H)×2048(V) / 2040(H)×1530(V)
	Visual Pixels	2448(H)×2048(V) / 2040(H)×1530(V)	1958(H)×1638(V) / 1632(H)×1224(V)
	Scanning Method	Progressive Scan	
	Frame Rate	50Frame1 / Sec(Max)	
	Live HDR	25Frame / Sec(Max)	
	Electronic Shutter	Auto, Manual 1~1/24000	
	Gain	Auto / Manual 0dB~12dB	
	White Balance	AUTO(One Push), MANUAL(R,G,B)	
Back Focus	NOT Required		
Light Source	Lamp	High Intensity LED	
	Lamp Life	30,000hours(Average)	
	Color Temperature	5700K(Typical)	
Output	PC Interface	USB 3.0 Series A	
	Camera	USB 3.0 Series B	
Input	Stand Controller	Special Cable	
	USB Ports	USB 3.0 Series A×2	
	Interface	LAN, USB 3.0 / 2.0, HDMI, Others	
Power	Supply Voltage	AC100V~240V 50/60Hz	
	Consumption	200W	
Environmental Resistance	Ambient Temperature	5~40°C(41~104F)	
	Relative Humidity	20~80% RH(No Condensation)	
	Atmosphere	Corrosive Gas Prohibited	
	Altitude	Below 2000Meter	
	Storage Temperature	-15°C~50°C(No Condensation)	
	Contamination Degree	2	
Weight	Overvoltage Level	II	
	Main Unit	Approx. 2.5Kg(5.51lb)	
Dimension	Camera Unit	Approx. 1.0Kg(2.20lb)	
	Main Unit	130mm(W)×243.6mm(H)×275mm(D) 5.11"(W)×9.59"(H)×10.83"(D)	

## Recommend Minimum PC Specification

	Intel Core i7 7th Generation or Higher	Intel Core i5 7th Generation or Higher
Work Station PC	CPU	Intel Core i5 7th Generation or Higher
	LAM	16GM Memory or Higher
	Monitor	1080×1920 Resolution
	Interface	USB 3.0 Series A×4 or more
	HDD / SSD	512GB or Higher
	OS	Windows 10 - 64 bit

## Basic Functions: Stand and Stage

Model	ST-AS	
Stand Base	Inclination	150Degree(90Degree on Right and 60Degree on Left)
	Positioning	Inclination Angle Detection Sensor
		XY Stage Vertical Movement and Height Detection Sensor
	Transmitted Lighting	Integrated High Intensity LED Lighting
	External Lighting	Dual Goose Neck Lighting(Optional)
	Weight	11.5kg
Z Axis	Effective Stroke	80mm(3.15")
	Resolution	5Phases Stepping Motor
		0.05um(0.002 Mil) / Pulse
Travel Speed	15mm / Sec at Max	

Model	AS-50	AS-100	AS-M	
XY Stage	Effective Stroke	50×50mm(1.97"×1.97")	100×100mm(3.94"×3.94")	76×51mm(2.99"×2.01")
	Effective Stroke	2Phases Stepping Motor		Manual
		0.15625um(0.006Mil) / Pulse		N/A
	Travel Speed	7.45mm / Sec at Max	7.45mm / Sec at Max	N/A
	Load Capacity	3.0kg		1.0kg
	Stage Plate Size	170×170mm(6.69"×6.69")	240×235mm(9.49"×9.25")	240×180mm(9.49"×7.09")
	θ Stage	Center Disk Size 4", 5" and 6"		N/A
	Dimension	255(W)×228(D)×62(H)mm	294(W)×293(D)×62(H)mm	240(W)×180(D)×60.7(H)mm
	Weight	About 4kg	About 6kg	1.5kg

For more detail information, please contact our sales office.

**Hirox Co.,Ltd.** <https://www.hirox.com>  
Tel: (+81) 3-3311-9911 E-mail: tokyo2@hirox.com

**Hirox-USA Inc.** <https://www.hirox-usa.com>  
Tel: (201) 342-2600 Toll-Free: (866) HIROX-US E-mail: info@hirox-usa.com

**Hirox China Co.,Ltd.** <http://www.hirox.com.cn>  
Tel: +86-21-6564-7772 E-mail: info@hirox.com.cn

**Hirox Korea Co.,Ltd.** <http://www.hiroxkorea.com>  
Tel: +82-31-385-1130 E-mail: yoon@hiroxkorea.com

**Hirox Asia Ltd.** <http://www.hirox-asia.com>  
Tel: +852 8198-9679 E-mail: info@hirox-asia.com

**Hirox Europe Ltd.** <https://www.hirox-europe.com>  
Tel: +33 426 25 03 40 E-mail: info@hirox-europe.com